

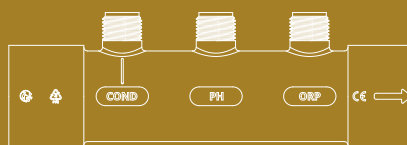

# WIS IN LINE QUICKSTART GUIDE

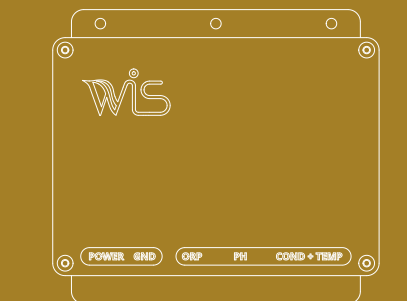

01

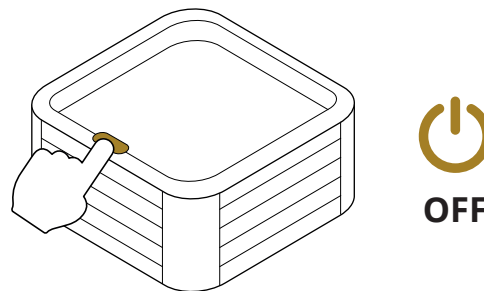

### Power off the spa

For your safety, it is best to turn off the main power supply

02

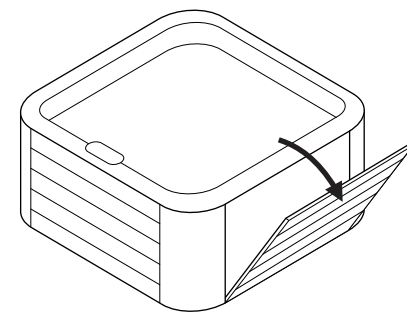

### Open the side panel of your spa to access the unit control box



Installation must be done by a professional

03

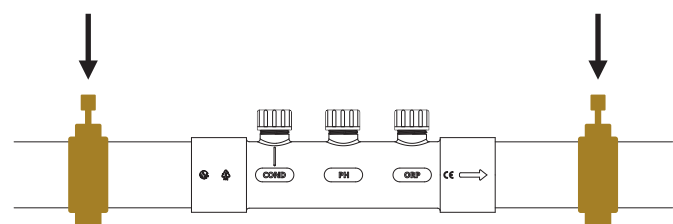

### Close the slice valves

04

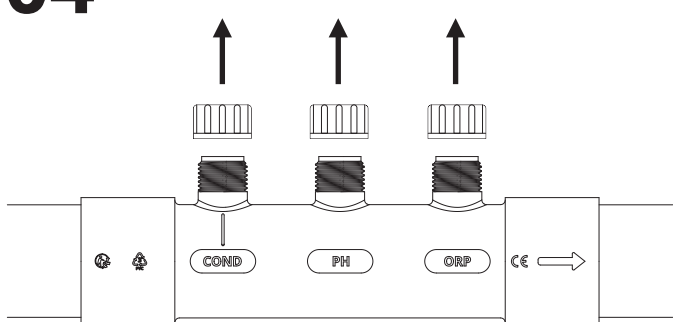

### Remove the manifold caps

05



1



2



3



4



5

### Install the compression fittings



Store the sensor boxes and end caps

06



Turn conductivity sensor: water flow passing through the hole

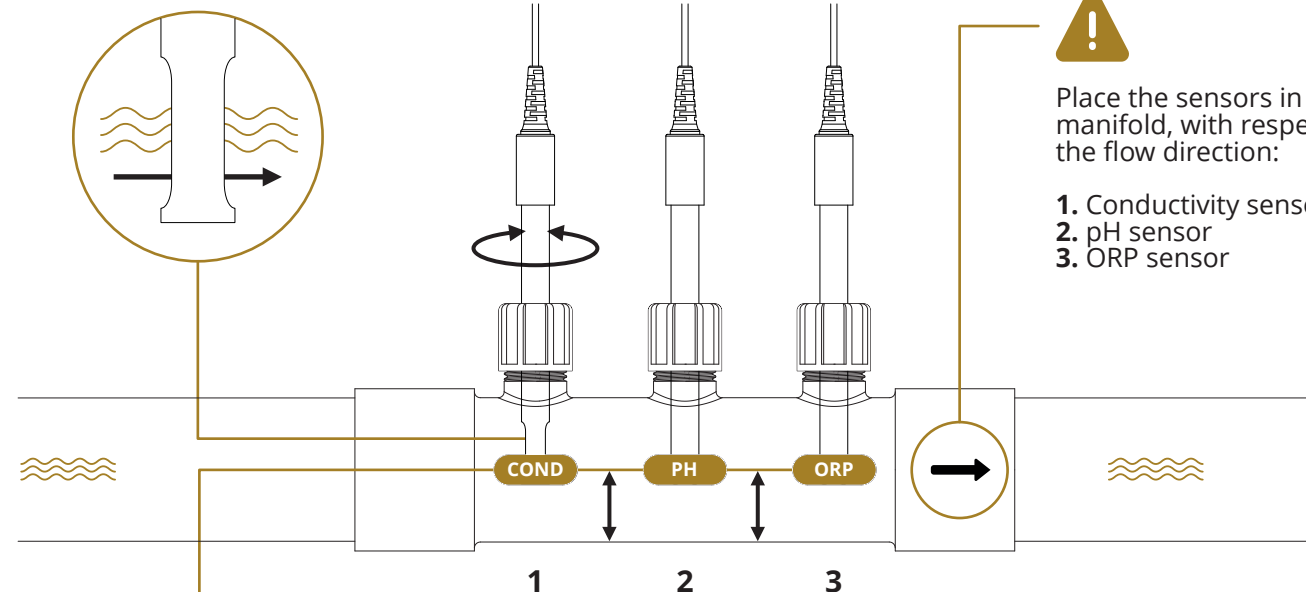

### Screw the sensors on the manifold



Place the sensors in the manifold, with respect to the flow direction:

1. Conductivity sensor
2. pH sensor
3. ORP sensor

Place the end of the sensors in the middle of the manifold

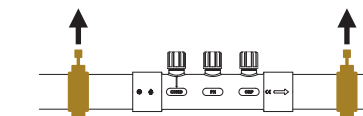

### Open the slice valves

07

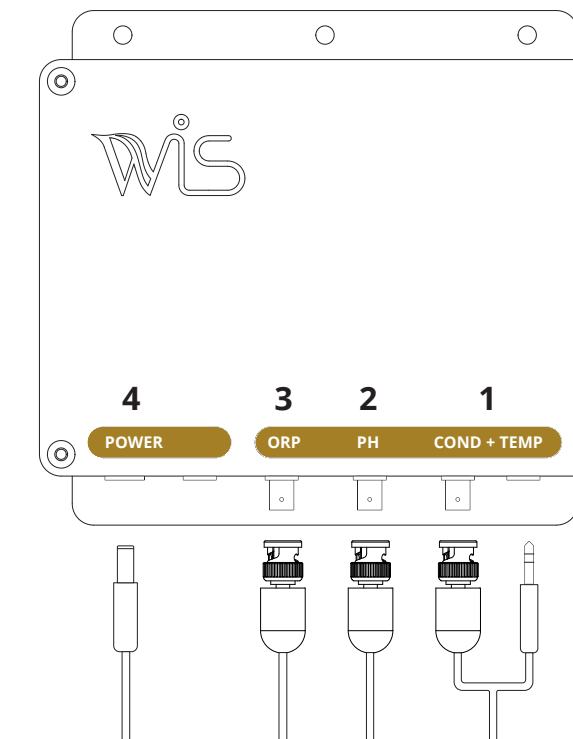

### Connect the sensors to the control box

08

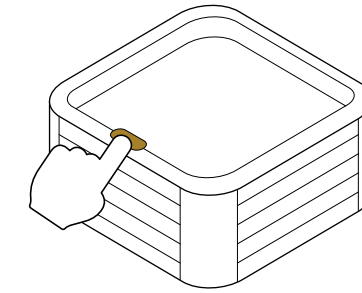

Restore the power supply to the Spa to turn on WIS IN LINE

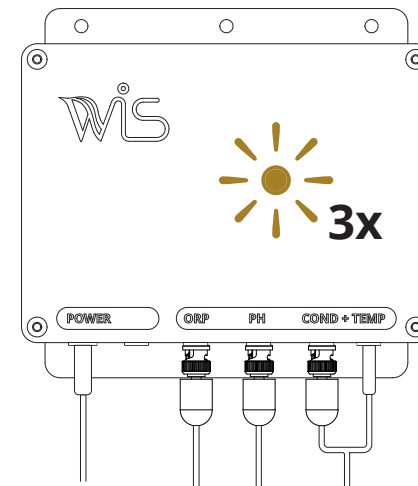

09

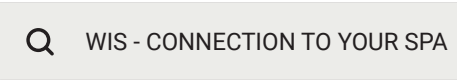

Download the application (free App)



Download the application on the user's phone

10

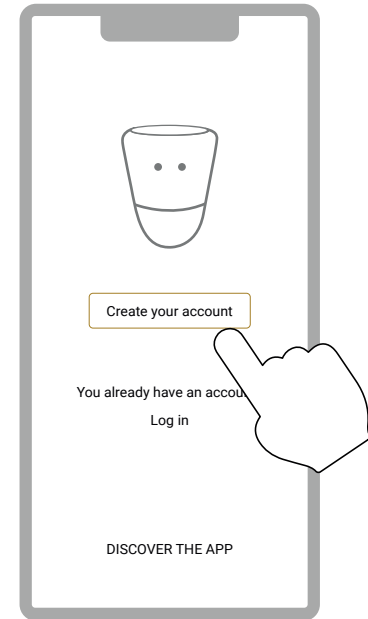

Create your account

11

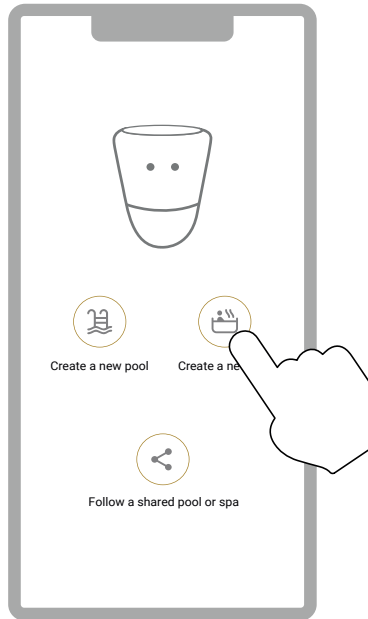

Create a new spa

12

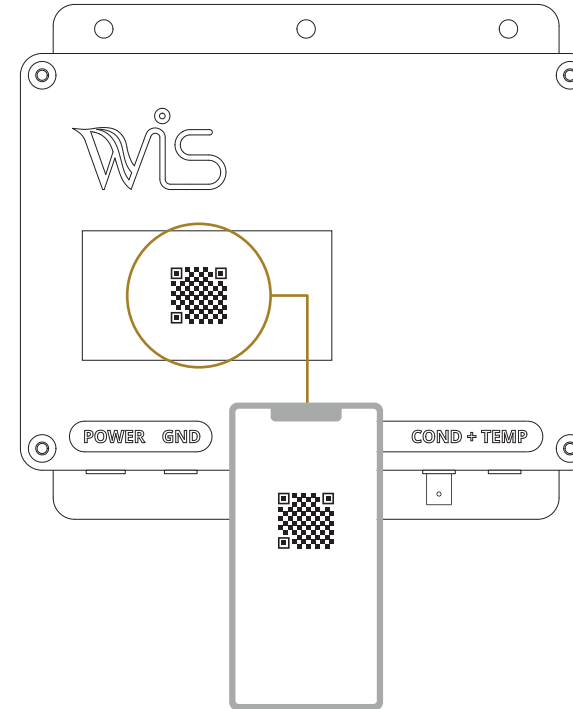

Scan QR code and follow the instructions

13

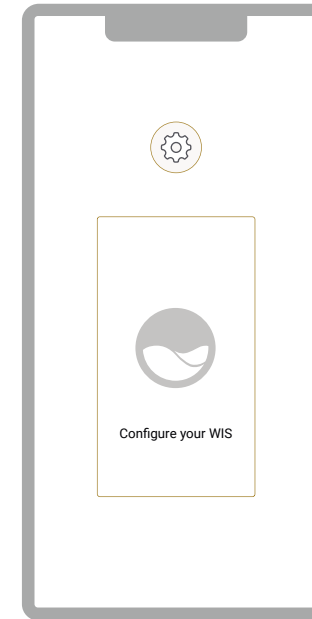

Configure your WIS

Follow the WiFi connection steps in the app

Wellis

www.wellis.com



ANY QUESTIONS?